

MODEL 282-24

Includes (8) 3 $\frac{7}{8}$ "W Aluminum Product Trays (0022520) and (2) 8"W Aluminum Product Trays (0022591)

MODEL 282-24-R

Includes (4) Flat Grill Racks (0022542)

The perfect merchandiser for all your hot fast foods. Compact display unit is designed for maximum visibility and extended shelf life. Featuring product illumination for both shelves and an adjustable thermostat to keep your products at just the right serving temperature.

FEATURES:

- Thermostatically controlled heated shelf and base plate
- Adjustable thermostat for precise temperature control
- Temperature range to above 150° F
- Illuminated to showcase product on both heated surfaces
- (2) 2" x 24" display channels that allow you to slide in custom graphics (max. thickness: 0.025")
- Sturdy, durable stainless steel construction
- Slanted shelf/base units available that have the top shelf and base angled down 6° in front: Models: 282-24-S or 282-24-SR

AVAILABLE ACCESSORIES:

- #0022544SK Acrylic Sneeze Guard (NSF does not require usage of sneeze guard on this model)
- #00225203 $\frac{7}{8}$ "W Aluminum Product Tray (unit holds 6 trays per surface)
- #00225918"W Aluminum product Tray (unit holds 3 trays per surface)
- #0022542 Flat Grill Rack (unit holds 2 racks per surface)
- #0022521 Divider Bar
- #0022523 Sign Holder (holds sign: 21"L x 9 $\frac{1}{2}$ "H, max. thickness: $\frac{1}{8}$ ")

FOR EXTENDED SHELF LIFE, WE RECOMMEND:

- Product Trays for wrapped sandwiches
- Flat Racks for plastic containers or wrapped products

ELECTRICAL DATA:

VOLTS:	120	AMPS:	12.5	WATTS:	1500
---------------	-----	--------------	------	---------------	------

- Best when operated on an individual branch circuit
- Approx. 70" power cord length

DIMENSIONS:



- External: 21"W x 25"D x 20 $\frac{1}{2}$ "H
- Base: 24"W x 17"D
- Shelf: 24"W x 17"D

SHIPPING INFORMATION:





- SHIPPING DIMENSIONS: 22"W x 30"D x 24"H
- SHIPPING WEIGHT: 66 LBS.



IMPORTANT: Read the following safety and operation instructions to avoid damage to equipment or property.

-  Plug unit into a properly grounded electrical outlet of the correct voltage, size, and plug configuration for this unit. We recommend usage on an individual branch circuit of at least 15 amps for best results. Failure to do so may result in decreased performance of the warmer.
-  Exterior surfaces on unit may get hot. Use caution when touching these areas to avoid injury.
-  Unplug warmer when not in use.

CLEANING INSTRUCTIONS:

-  Unit is not waterproof. Do not submerge in water. Do not operate if unit has been submerged in water.
-  Unplug unit from power source, and allow to cool completely before performing any maintenance or cleaning.
-  Do not steam clean or use excessive water on unit to avoid personal injury or electrical shock.
-  It is recommended that the interior and exterior surfaces be cleaned daily with a mild soap and damp cloth. Stubborn stains on base of unit and/or shelves may be removed with a non-abrasive cleaner and a damp cloth. Usage of an abrasive cleanser could scratch or damage the finish of your unit.

The optional sneeze guard accessory should be wiped daily with a mild soap and damp cloth only. Use of glass cleaners may cause the acrylic to crack, fog, scratch, etc.

OPERATION:

This warmer is designed to maintain food product at or above the optimum temperature. It is not designed or intended to heat up or cook food to the serving temperature. Product is to be prepared to a temperature of above 160°F before placing in the warmer. Do not place product on its side as this will affect the internal holding temperatures of the product.

TEMPERATURE:

The amount of product placed in the warmer will affect the performance of the warmer. We suggest periodically checking the internal temperature of the product and adjusting the temperature settings if necessary. The following temperatures are **APPROXIMATE** and can vary due to unit location, electrical supply, product used, etc. Intended as a guideline only.

SETTING	TEMPERATURE READING
1	80° F
1.5	95° F
2	105° F
2.5	110° F
3	125° F
3.5	140° F
4	150° F
4.5	155° F
5	160° F

MAINTENANCE:

TO REPLACE DISPLAY LIGHT:

Disconnect the power supply cord, and wait until unit has completely cooled. Unscrew light, and replace with a new specially coated bulb of the same style and wattage.

MAINTENANCE:



Unplug unit from power source, and allow to cool completely before performing any maintenance or cleaning.

Unit not working:

- Check the power switch position, power cord, and/or electrical circuit.

Display light not working:

- Tighten or replace the bulb.

Unit not heating properly:

- Has food been prepared in advance and placed in warmer at proper serving temperature?
- Check heat settings. Is it at correct setting for your food product?

NOTES:

PARTS LIST:

MODEL 282-24

ITEM #	PART#	DESCRIPTION
1.	0022532	550W CALROD ELEMENT
2.	0022535	40W BULB - NON COATED
	0027187	40W BULB - SILICONE COATED
3.	0022542	FLAT RACK
4.	0022521	DIVIDER BAR
5.	0022520	4" BLACK ALUMINUM PRODUCT TRAY
6.	0022591	8" BLACK ALUMINUM PRODUCT TRAY\
7.	0016123	THERMOMETER
8.	0022519	SIDE RAIL
9.	00132	POWER CORD
10.	I013163	THERMOSTAT DIAL
11.	0016157	THERMOSTAT KNOB
12.	0022534	REGULATING THERMOSTAT
13.	00131	STRAIN RELIEF
14.	00486	POWER SWITCH
15.	0023040SK	BOTTOM FOOT SERVICE KIT
16.	0022501-086	BASE ASSY
17.	0022582	24" X 2" C CHANNEL WITH ADHESIVE
18.	0022586	24" ANGLED SIDE RAIL WELDMENT
19.	0022582-24	SIDERAIL ASSY 24" W/2" C CHANNEL
20.	0022533	HEATER, FOIL, 120V, 240W
*	0022544SK	FOOD SHIELD/SNEEZE GUARD
*	0022523	SIGN HOLDER
*	00282-486SK	282 SWITCH SERVICE KIT
*	0022246	LIGHT SOCKET ASSEMBLY

MODEL 282-24 EXPLODED VIEW:

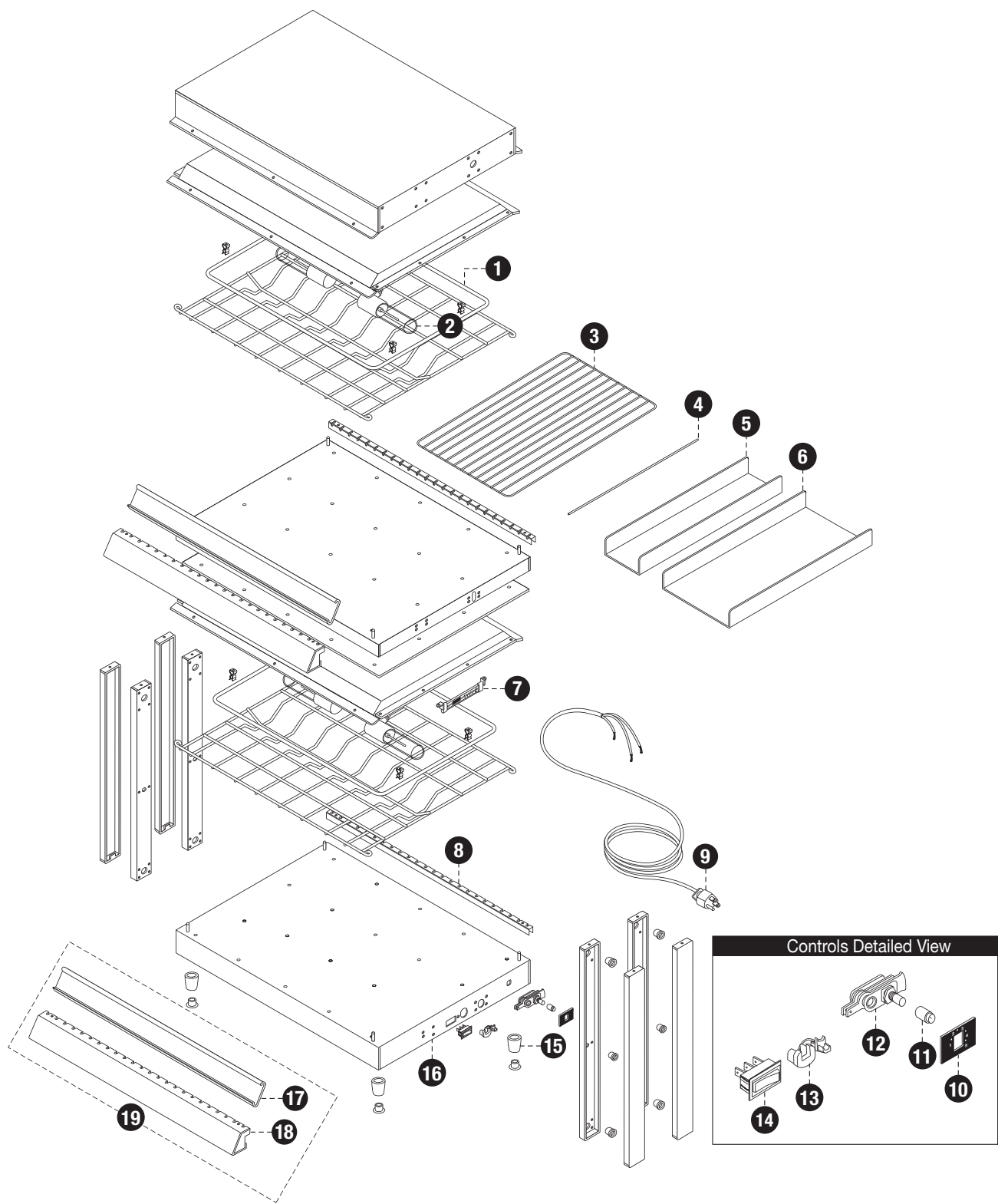

Model 282-24 Wiring Diagram

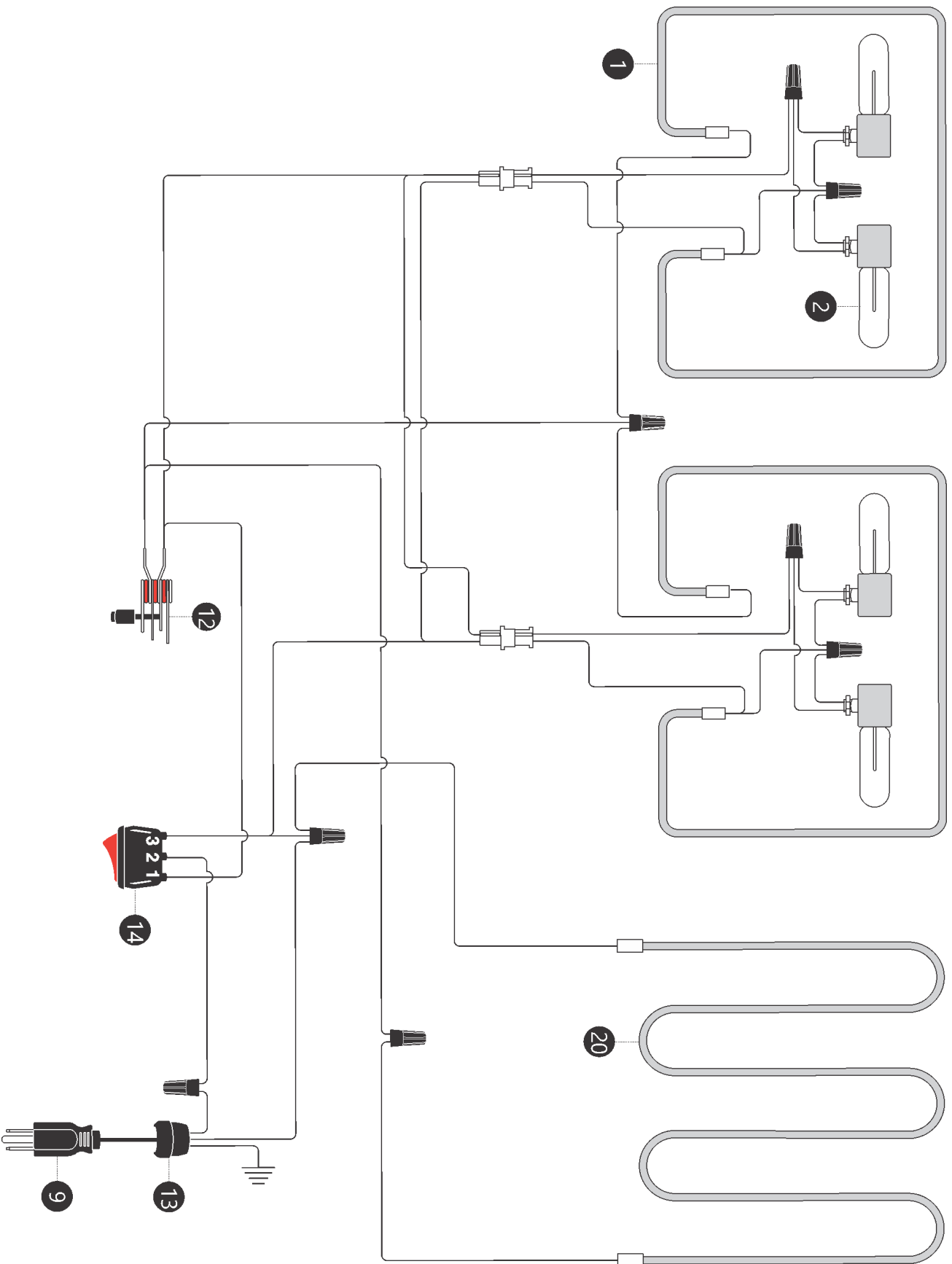



LIMITED WARRANTY/ RETURN POLICY

1 YEAR REPLACEMENT/EXCHANGE

Wisco Industries, Inc. warrants its equipment against defects in materials and workmanship subject to the following conditions:

Should any product fail to function in its intended manner under normal use within the limits defined in this warranty, Wisco Industries will determine if the item is to be repaired or replaced by Wisco Industries. Failure to follow authorizing instructions may void any claim and/or warranty.

* Contact Wisco Industries for repair/replacement by calling (608) 835-3106 or toll free (800) 999-4726.

You can also email us at: contact@wiscoind.com

* An authorizing RMA# must be obtained through Wisco Industries BEFORE any warranty issues can be resolved. Failure to do so in advance may void the warranty/claim resulting in Wisco Industries not being responsible for any incurred expenses and/or charges.

* At time of call Wisco Industries will assist you in:

- getting your unit replaced/exchanged
- and/or obtaining repair parts
- and/or authorizing a service agent

This warranty covers products shipped into the 48 contiguous United States, Hawaii and metropolitan areas of Alaska only. Warranty for international or areas not listed above will consist of replacement of parts only. There will be no labor coverage and parts must be shipped to an address within the 48 contiguous United States, Hawaii or metropolitan areas of Alaska only.

Time Period

One year from date of shipment from our manufacturing facility. Parts replaced under this warranty are warranted for the un-expired portion of the original product warranty only.

Exclusions

The following conditions are not covered by warranty:

- Equipment failure relating to improper installation and improper utility connection or supply.
- Equipment that has not been properly maintained or damage from improper cleaning and/or water damage to controls.
- Equipment that has not been used for its intended purpose or has been subject to misuse or misapplication, neglect, abuse, accident, alteration, negligence, damage during subsequent transit, delivery or installation, fire, flood, riot or act of god.
- Equipment that has the model number or serial number removed or altered.

WISCO INDUSTRIES, INC. DISCLAIMS AND EXCLUDES ANY AND ALL OTHER EXPRESS OR IMPLIED WARRANTIES, INCLUDING WITHOUT LIMITATION, ANY AND ALL WARRANTIES OF MERCHANTABILITY OR FITNESS FOR A PARTICULAR PURPOSE.

Buyer agrees that its SOLE AND EXCLUSIVE REMEDY against Wisco and Wisco's SOLE AND EXCLUSIVE LIABILITY arising out of any defect or nonconformity in the product shall be replacement/exchange of such nonconforming countertop food service equipment at Wisco's expense. No countertop food service equipment shall be returned without Wisco's consent. IT IS AGREED THAT WISCO'S MAXIMUM LIABILITY SHALL NOT IN ANY CASE EXCEED THE SALE PRICE FOR THE COUNTERTOP EQUIPMENT CLAIMED TO BE DEFECTIVE OR NONCONFORMING.

Without limiting the generality of the foregoing, SUCH WARRANTIES DO NOT COVER: Glass, plastic enclosures/panels, door assemblies, hardware, light bulbs & wire pizza oven heating elements.

SHIPPING DAMAGE

If the outside packaging of your order is visibly dented, crushed, torn or otherwise significantly damaged, or if you move the carton and you hear broken glass, please reject the shipment while driver is still with you if possible. Please call us at (800)999-4726 or email contact@wiscoind.com to notify us of the issue. We will confirm the damage with the carrier and re-ship your order immediately.

RETURN POLICY

You may return any unused, undamaged items within 30 days of receipt at your expense. We will issue a refund in the form of your original payment, less a 20% restock fee. Wisco Industries will not reimburse any shipping and handling fees. All returns must be received in resalable condition. Wisco Industries will not accept a return with shipping damage.

If you would like to return an item please call us at 608-835-3106 or toll free at 1-800-999-4726 and ask for our Food Service Equipment Division or you may send an email to us at: contact@wiscoind.com You will be given a return # and return instructions. We can not accept returns without a return #. Please be sure to include a copy of the packing list with the return.